

IVS SMART VEHICLE TRACKING SYSTEM

Model No: IGSV05

USER MANUAL



TABLE OF CONTENTS

GETTING STARTED	1
Starting UP with IVS Smart GPS Tracker	1
Salient FEATURES:	1
What's Included	2
VIEWING YOUR DATA on Mobile App	2
VIEWING YOUR DATA on Web Portal	3
SETTING UP	4
Starting UP with IVS Smart GPS Tracker	4
Download and SETUP the Device.....	5
Wiring Indication.....	6
Troubleshoot	7
CONTACT US FOR SUPPORT	8

GETTING STARTED

STARTING UP WITH IVS SMART GPS TRACKER

IVS Smart Vehicle Tracking System comes with GPS Tracker, App, SIM & Service Support & 1 Year Warranty!

Stay connected and informed with IVS Smart Vehicle Tracking System Real-Time Position GPS Locator, featuring real-time location updates.

SALIENT FEATURES:

- Live Vehicle Tracking.
- Geo-Fencing and Alerts when Vehicle "In "and "Out "from a marked Zone
- Anti-Theft: Integrate with other sensors for Engine Stop and Start in case of Theft.
- Over Speed Alert.
- Distance & Trip Tracking.
- Follow the Live Vehicle via App
- Show Vehicle Route History and Playback
- Power Off Notification
- Usage: Car, Bus, Truck, Scotty, Bike and any EV or Any Vehicles

WHAT'S INCLUDED

IVS Smart Health Scale box includes:

- IVS Smart GPS Tracker Device & Wire
- SIM
- 1 User Guide

VIEWING YOUR DATA ON MOBILE APP

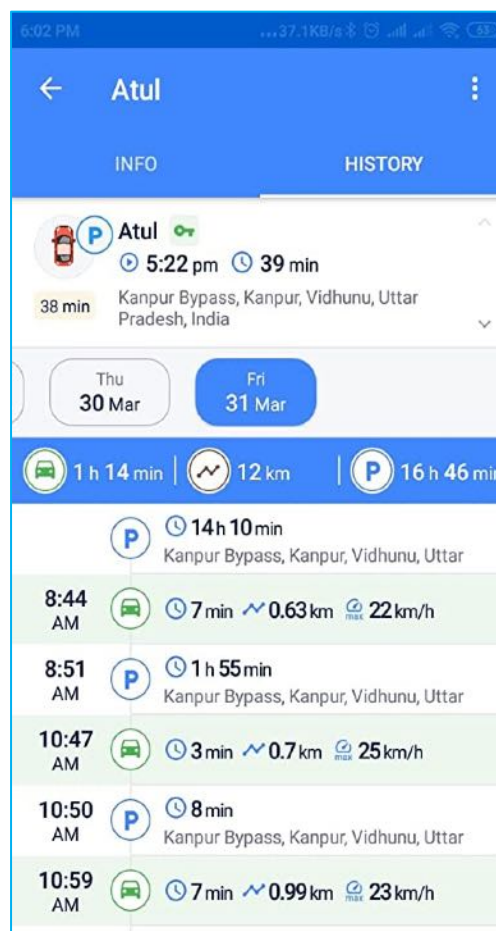
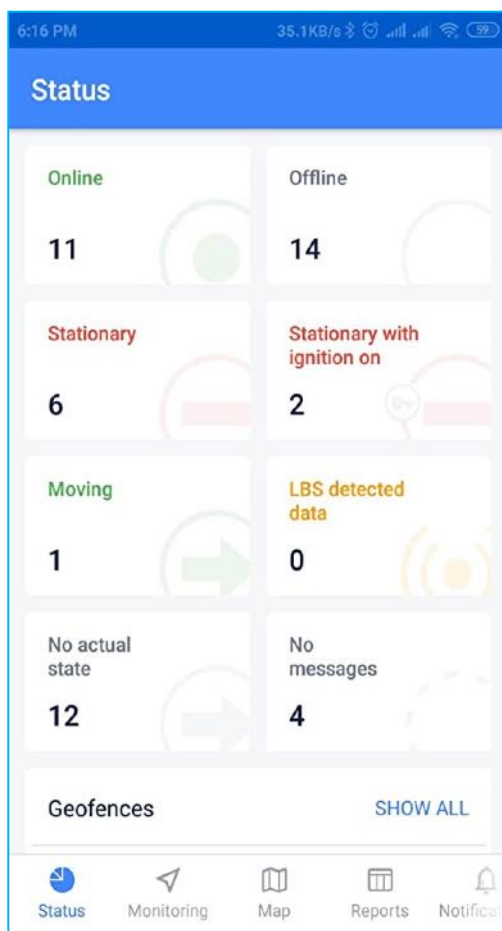

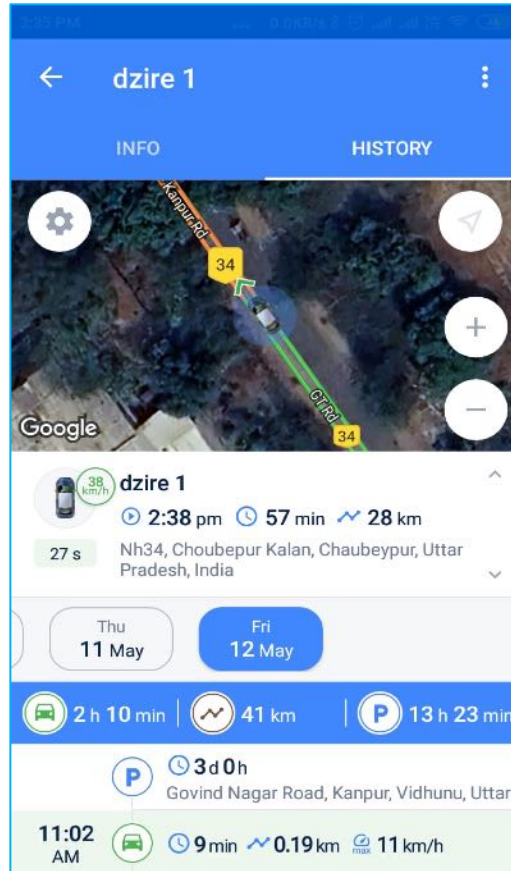
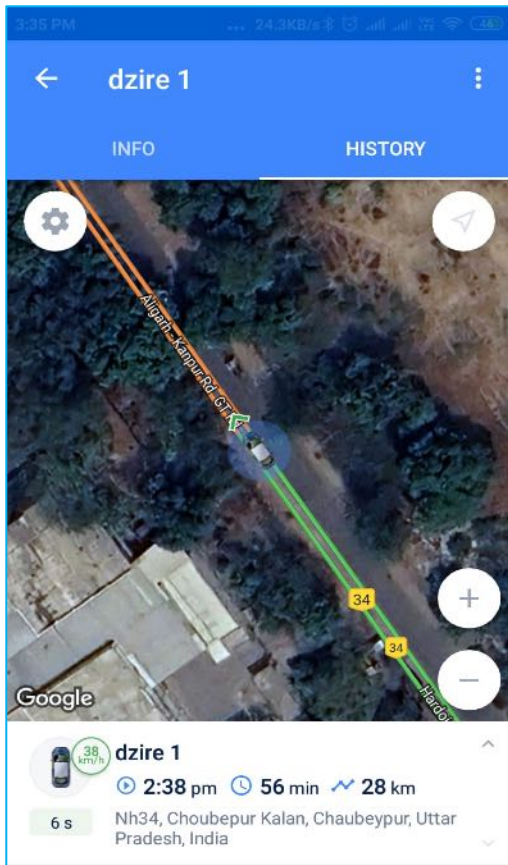

VIEWING YOUR DATA ON WEB PORTAL

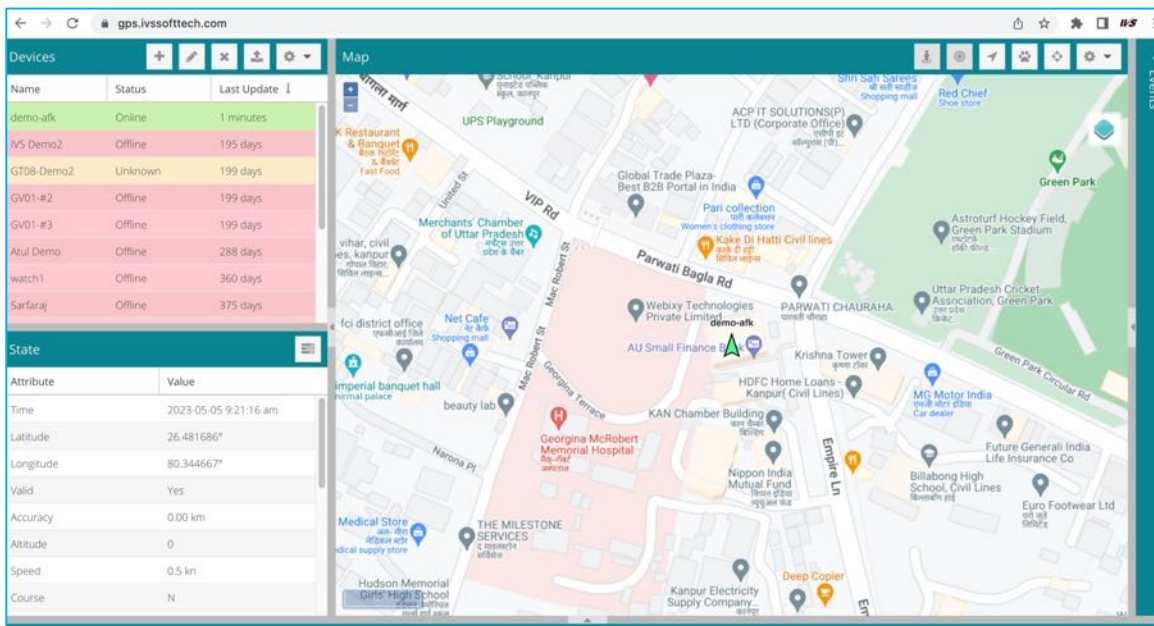

SETTING UP

STARTING UP WITH IVS SMART GPS TRACKER

IVS Smart Vehicle Tracking System is shipped with GPS Tracker, Wire, SIM and Manual.

Please follow below steps for installation recommendation and usage.

SENALM.OFF#	Disabled vibration alarm	
SENALM#	Check the alarm setting	
RESET#	Reboot	Device will reboot in 20s

Installation recommendation

Please install the device under the guidance of professional personnel.

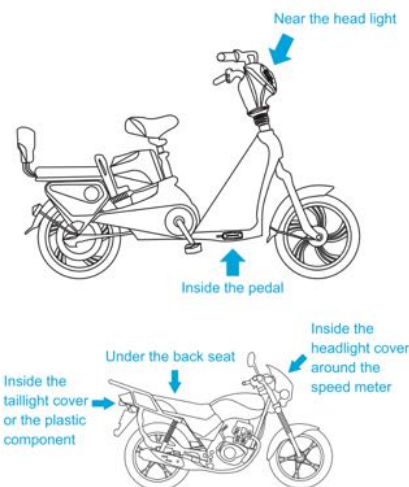

Near the head light

Inside the pedal

Under the back seat

Inside the taillight cover or the plastic component



Inside the taillight cover

Under the pedal

Inside the front cover

Note:
The device should face up to the sky.
Metal thermal barrier or heating layer of the windshield affects the signal. Please change installation places to receive better signal.

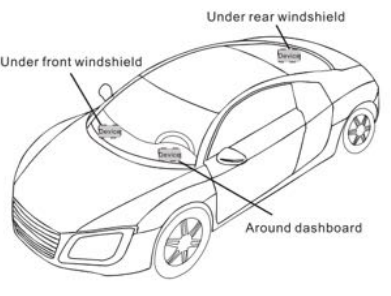

Under front windshield

Under rear windshield

Around dashboard

DOWNLOAD AND SETUP THE DEVICE

Go to the App store on your device (App Store for iOS or Play Store Android) to download the app.

Place the SIM as per Instructions below.

Insert sim card and power on

1. Choose Micro SIM card with access to GPRS and SMS.



2. Gently remove the cover and switch off the device, then insert SIM card into SIM card slot.

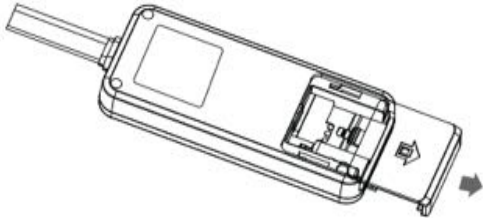

3. Switch on the device and push the cover back.

WIRING INDICATION

After SIM and App installation, Complete the wiring as per below indications.

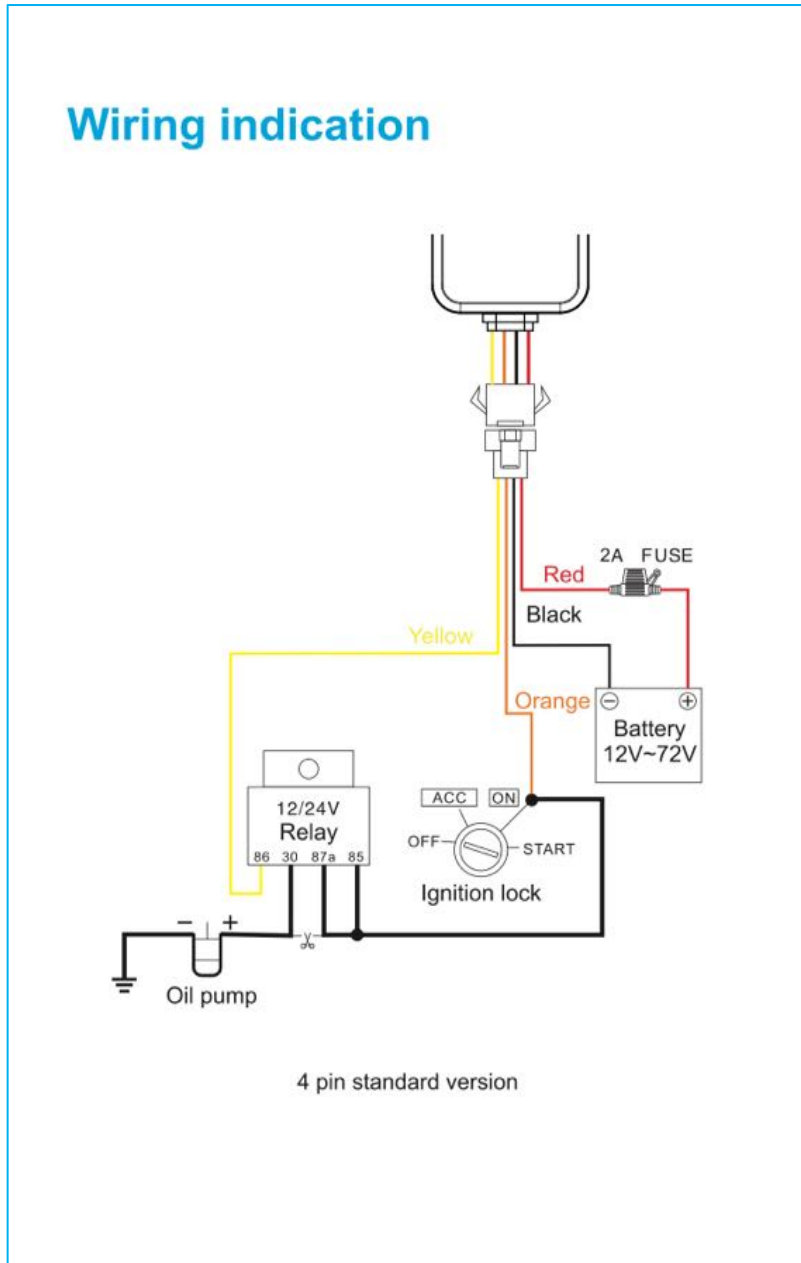

TROUBLESHOOT

For troubleshooting follow LED indications.

LED indications

GNSS Status(Blue)

Blinking	GNSS synchronizing
Solid on	Positioned
Off	GNSS module is in sleep mode or is not active

GSM Status(Green)

Quick blinking (0.3s on, 0.3s off)	Module initializing
Slow blinking (0.3s on, 2s off)	Normal signal receiving
Solid on	GSM call/ GPRS is active
Off	No signal received or no SIM card detected

Power Status(Blue & Green)

Blue and Green indicator solid on for 3s	External power supply connected
--	---------------------------------

CONTACT US FOR SUPPORT

NAME & ADDRESS OF MANUFACTURER AND COSTUMER CARE

IVS Softech® Private Limited,
LIG-1376, Awas Vikash-3,
Kalyanpur, Kanpur,
Uttar Pradesh, Pincode-208017

Mobile: +91 9450746793 / +91 9793201037,

Email: support@ivssofttech.com & contact@ivssofttech.com,

Website: <https://www.ivssofttech.com/>

Facebook: <https://www.facebook.com/ivssofttech/>

Twitter: https://twitter.com/IVS_Softtech

WhatsApp Support: +91 9450746793 / +91 9793201037,